

# SETTING UP THE CANOPY

## 1 OPENING THE CANOPY FRAME

- With a partner, stand across from each other.
- Grasp a truss at the top of the frame (B) and the other truss at the bottom, as shown. Lift slightly off ground and step backwards while squeezing trusses together.

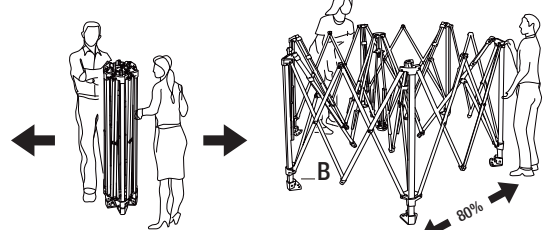

**IMPORTANT:** Lift up the frame 2"-3" off the ground especially in tall grass or sand. Grasp the trusses away from the connections to avoid pinching. Get the frame 80%-90% opened. Grasp the trusses away from the connections to avoid pinching.

## 2 ATTACHING THE CANOPY TOP

- Unfold the canopy (A) and place on top of the canopy frame (B).
- Secure the canopy (A) top to the corners of the canopy frame (B) using the Velcro connections.

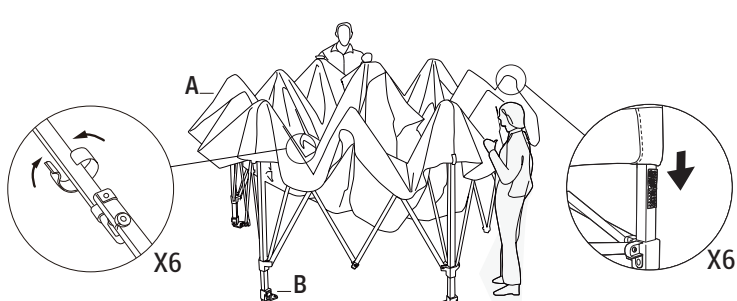

**IMPORTANT:** Find the corners of the canopy before draping over frame. Do not attach the canopy while the frame is fully extended.

## 3 LOCKING THE FRAME

- Lift up one side of the frame (B) and walk under it.
- Place one hand on the upper frame and use the other hand to push the central hub straight up until it clicks into the central pole.

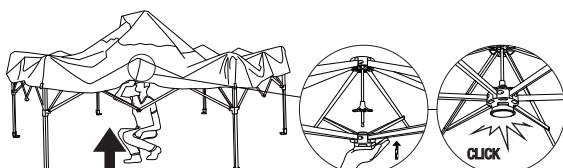

**IMPORTANT:** Lift the frame slightly off the ground while pushing up hub. Use both hands to guide the pole into the hub.

## 4 ADJUSTING THE CANOPY HEIGHT

- Lift up one side. Grasp the outer or upper leg with one hand and pull out the inner leg with the other.
- Extend until the button engages.
- Set legs to desired height.

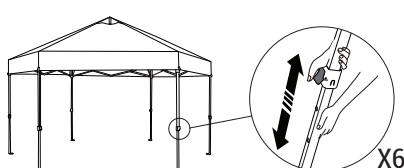

**IMPORTANT:** Do not keep your foot on the footplate while extending the leg. This creates tension to cause frame damage. Only extend legs after the central lock is engaged. Utilize the various height adjustment to create a level shade.

## 5 SECURING THE CANOPY IN PLACE

- Insert a stake (C) into the foot pad of the leg.
- Fill up the weight bags (D) with sand or gravel and simply use the hook and loop strap around each leg.



**IMPORTANT:** Always secure your canopy with the weight bags and stakes.

# TAKING DOWN THE CANOPY

## 1 REMOVING THE STAKES AND RETRACTING THE LEGS

- Remove all weight bags and stakes from the ground.
- Press the push button to lower all legs.

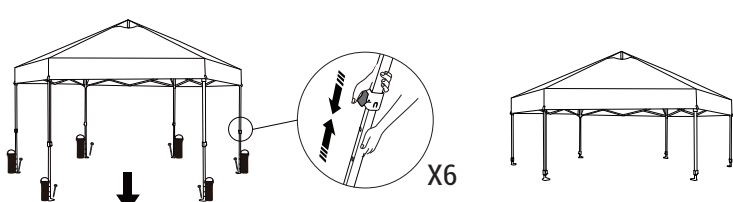

## 2 UNLOCKING THE CANOPY

- From underneath the canopy, press in the red lock button.
- Pull down on the central hub until it is separated from the central pole.

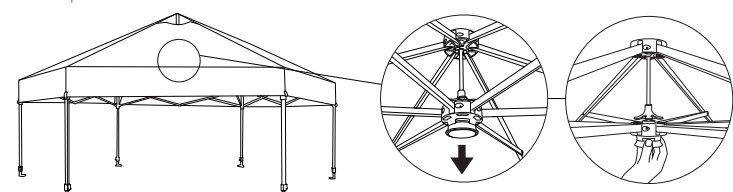

## 3 FOLDING THE FRAME

- Lift the canopy off the ground 2-3 inches and walk it in from both sides until the frame is fully closed.

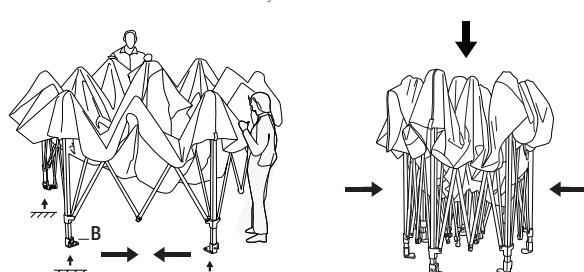

## 4 PACKING THE CANOPY IN THE STORAGE BAG

- With the canopy feet facing the rollers, slide the wheeled storage bag over the closed canopy frame.
- Close the zipper on the wheeled storage bag.

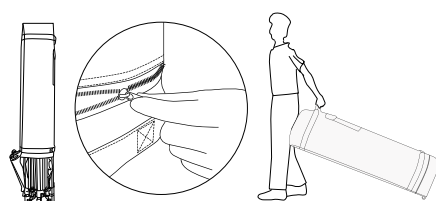

# Warranty

The manufacturer warrants for a period of 1 year from the original date of purchase, this product against any defects in materials or workmanship. At its discretion, the manufacturer may provide replacement parts to the original purchaser. Original receipt or proof of purchase as well as proof of defect is required. The manufacturer will not be responsible for shipping costs incurred outside the continental USA. Warranty is valid for the original purchaser 1 year from the date of purchase and is not transferable. This warranty does not cover any product purchased through non-authorized dealers and/or online auction websites.

## WHAT IS NOT COVERED

This 1 Year Limited Warranty does not cover normal wear and tear, abuse or misuse of this product including damage from inclement weather conditions, such as wind, rain, or hail. In case of inclement weather, remove all valuables and persons and seek appropriate shelter. Under no circumstances will the manufacturer be liable or responsible for any incidental or consequential damages. This product is designed and intended for recreational use only. Prolonged exposure to UV rays will cause any fabric to fade and deteriorate and is NOT covered by this 1 Year Limited Warranty. All replacement products or parts will assume the remaining warranty of the original product. This warranty gives you specific legal rights. You may also have other rights which vary from state to state.

# SPARE PARTS

**NEED ASSISTANCE?**

Please contact our customer service team.

Service@crownsadesusa.com  
Toll Free (888) 877-6789  
Mon-Fri 9:00 AM - 5:00 PM PST  
www.crown-outdoor.com

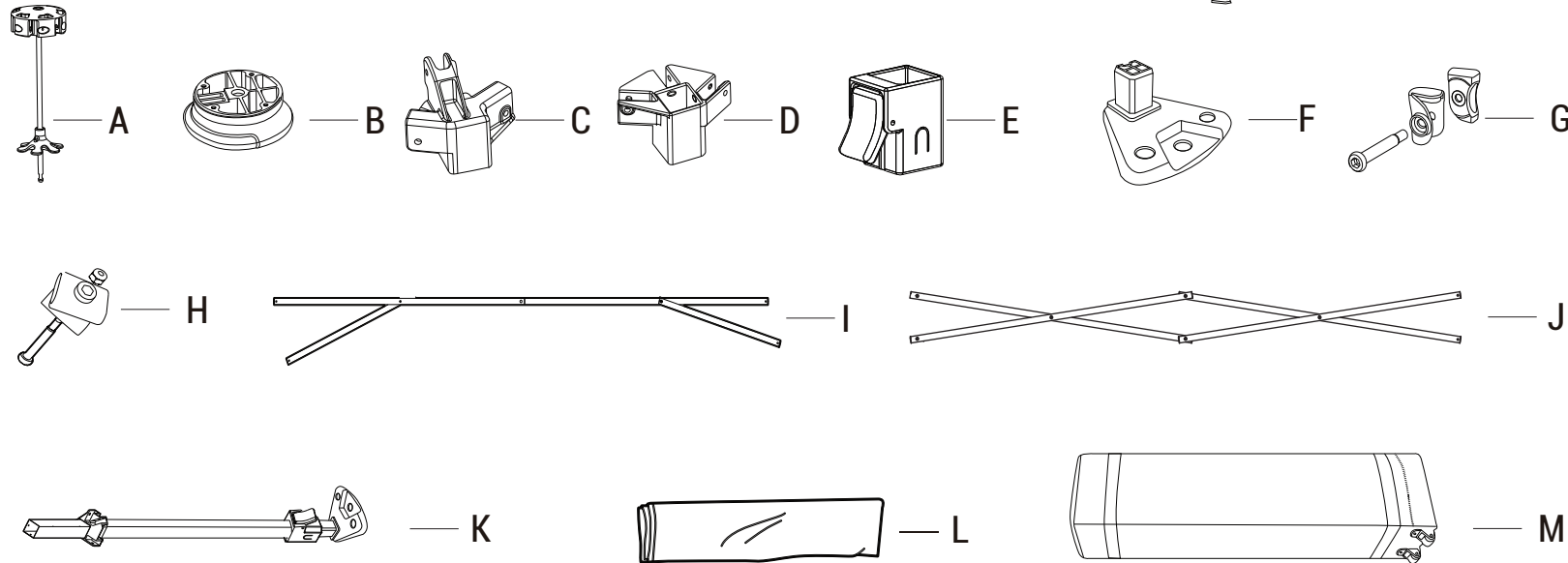
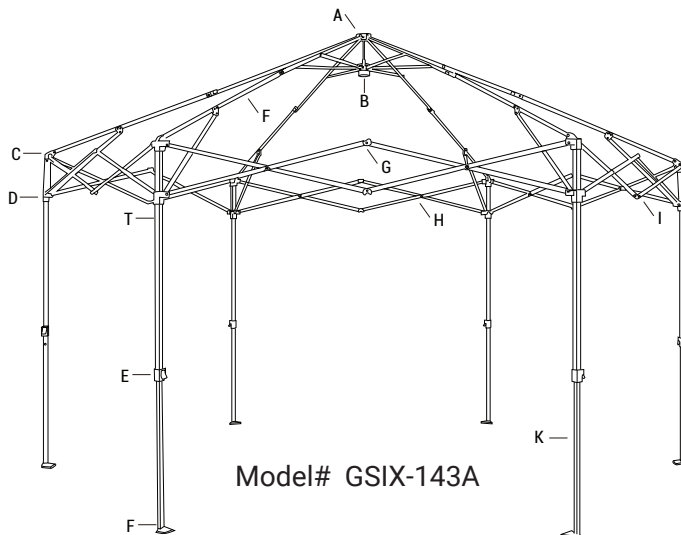

Part	Description	Reference No.
A	Central Pole	IXCP82BECL
B	Central Bottom Hub	IXCH00BE00
C	Leg Cap	IXLC11BE00
D	Slider	IXLS11BE00
E	Leg Extender	UNLE11BE4P
F	Plastic Foot	UNFT01BENW
G	M5 Bolt Kit	UNBKM5BE4P
H	M4 Bolt Kit	UNBKM4BE3P
I	Ceiling Assembly	IXCA07BE00
J	Eave Assembly	IXEA07BE00
K	Leg Without Wheel	IXLA07BENW
L	Top Fabric (khaki-coffee)	IXT107BEBR
M	Top Fabric (Red-Grey)	IXT107RDGY
N	Top Fabric (Blue/ LightGrey)	IXT107BLGY
O	Wheeled Bag	IXWB07BKSW